

Panasonic

Stereo Radio Cassette Player RQ-V207 Operating Instructions



Before connecting, operating or adjusting this product, please read these instructions completely. Please save this manual.

P PC

The serial number of this product can be found inside of the battery compartment.
Please note them in the space provided below and keep as a permanent record of your purchase to aid identification in the event of theft.
MODEL NUMBER RQ-V207
SERIAL NUMBER _____

User memo:

DATE OF PURCHASE _____
DEALER NAME _____
DEALER ADDRESS _____
TELEPHONE NUMBER _____

Matsushita Consumer Electronics Company, Division of Matsushita Electric Corporation of America
One Panasonic Way Secaucus, New Jersey 07094

Panasonic Sales Company, Division of Matsushita Electric of Puerto Rico, Inc. ("PSC")
Ave. 65 de Infanteria, Km. 9.5 San Gabriel Industrial Park, Carolina, Puerto Rico 00985

Matsushita Electric of Canada Limited
5770 Ambler Drive, Mississauga, Ontario L4W 2T3

Printed in Taiwan

RQTT0187-P
F0296F0

Supplied Accessories

Stereo headphones (RFEV702P-HS)



(Only for U.S.A.)

To order accessories call MSC Accessory Dept. 1-800-332-5368.

Belt clip (RKQT0002-R)



Attaching the belt clip

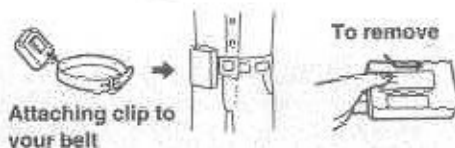
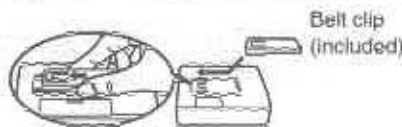

Before Operation

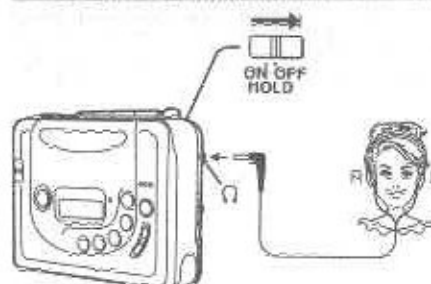

■ Connecting the headphones

Plug the included stereo headphones into the () jack.

■ To prevent unwanted operation

You cannot activate front panel buttons when the HOLD switch is set to "ON" (Hold state). Before using any of the front panel buttons, move the HOLD switch to "OFF" to release the hold state.

When the unit is in the hold state, the display shows "HOLD".

For your reference:

Since the hold function does not affect to side panel buttons, cassette tapes operations are available during the hold state.

Care and Use

• If the set is not used for a long period of time or is used only from an AC power source, remove all the batteries to prevent potential damage due to possible battery leakage.

• Avoid using or placing this unit near sources of heat. Do not leave it in an automobile exposed to direct sunlight for a long period of time with the doors and windows closed, as this may deform the cabinet.

• When not in use, disconnect the AC adaptor from the AC power outlet.

• Do not use rechargeable type batteries.

Cassette compartment cover:

If the catch is in the position shown in the figure (a), the cassette compartment cover doesn't close. If this occurs, slide OPEN so that the catch (b) is in the position shown in the figure (c).

If an attempt is made to close the cover forcibly, the compartment cover may get bent out of shape.

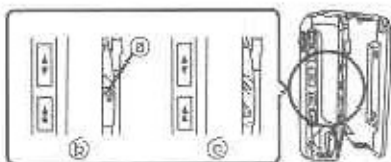

Cassette tapes

Improper tape storage

You can damage tape if you store it in the following ways:

- In high temperature or high humidity areas
- In a strong magnetic field (near a speaker, on top of a TV, etc.)
- In direct sunlight

Cassette tapes exceeding 100 minutes

These tapes are handy for their long playback and recording time but be careful about repeatedly stopping and starting, rewinding and fast forwarding these tapes in short intervals as they are thin, tend to stretch and may become entangled in the deck mechanism.

Listening caution



Do not play your headphones or earphones at a high volume. Hearing experts advise against continuous extended play.

If you experience a ringing in your ears, reduce volume or discontinue use.

Do not use while operating a motorized vehicle. It may create a traffic hazard and is illegal in many areas.

You should use extreme caution or temporarily discontinue use in potentially hazardous situations.

Even if your headphones or earphones is an open-air type designed to let you hear outside sounds, don't turn up the volume so high that you can't hear what's around you. Sound can be deceiving. Over time your hearing "comfort level" adapts to higher volumes of sound. So what sounds "normal" can actually be loud and harmful to your hearing. Guard against this by setting your equipment at a safe level BEFORE your hearing adapts.

To establish a safe level:

- Start your volume control at a low setting.
- Slowly increase the sound until you can hear it comfortably and clearly, and without distortion.

Once you have established a comfortable sound level:

- Set the dial and leave it there.

Maintenance

■ Head care

To ensure good sound quality for tape operation, be sure to clean the head after approximately every 10 hours of use. Clean it with a cotton swab dampened with a little alcohol. Do not bring metal articles or magnetic material such as a screwdriver, near the head assembly.

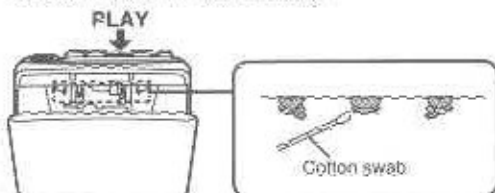

It is recommended that the head assembly be demagnetized if distortion or poor sound quality persists after cleaning the heads. Demagnetize them using a demagnetizer available from an audio store.

■ Main unit

Clean it with a cloth, dampened in a mild solution of soap and water.

Do not clean the cabinet with benzine or thinner.

Avoid excessive moisture.

Avoid spray aerosol type cleaner. Some cleaners contain corrosive chemicals that may cause internal damage and cabinet deformation.

Product Service

Do not attempt to remove the cover(s) or repair the unit yourself. Refer servicing to qualified personnel only.

■ Product information

For product service, product information or assistance with product operation, refer to the servicenter directory.

Troubleshooting Guide

Before requesting service for this unit, check the chart below for a possible cause of the problem you are experiencing. Some simple checks or a minor adjustment on your part may eliminate the problem and restore proper operation.

If you are in doubt about some of the check points, or if the remedies indicated in the chart do not solve the problem, refer to the directory of Authorized Service Centers (enclosed with this unit) to locate a convenient service center, or consult your dealer for instructions. (In U.S.A. consult MSC Authorized Servicenters for detailed instructions or call 1-800-645-2672 for the address of an authorized factory servicenter.)

Problem	Checkpoint	Remedy
No operations.	Have the batteries been installed with their polarities (⊕, ⊖) reversed?	Install them with their polarities (⊕, ⊖) aligned properly.
• No sounds. • VMS does not function.	Is the headphones plug connected to the headphones jack?	Plug the headphones plug into the jack.
No sounds during the tape playback.	Is the RADIO ON/OFF switch on?	Press RADIO ON/OFF to switch off the radio.
No radio operations.	Is the hold switch set to "HOLD"?	Release the hold state.

Technical Specifications

Radio frequency range:

FM: 87.9-107.9 MHz (0.2 MHz steps)
87.5-108.0 MHz (0.1 MHz/0.05 MHz steps)
AM: 520-1710 kHz (10 kHz steps)
522-1611 kHz (8 kHz steps)

Power requirement:

Battery: DC 3 V (Two AA size, (R6/LR6) batteries)
• Do not use rechargeable type batteries.
AC: DC IN 3 V with optional Panasonic AC adaptor RP-AC31

Frequency range

[Normal/high (CrO₂)/metal]: 40-16000 Hz
Tape speed: 4.8 cm/s (1 7/8 ips)

Jacks:

Input: DC IN: 3 V
Output: HEADPHONES
Dimensions (W×H×D): 114.3×86.6×37.9 mm (4 1/2"×3 3/8"×1 1/2")
191g (6.8oz.) without batteries

Weight:

Note: Specifications are subject to change without notice. Weight and dimensions are approximate.

THE FOLLOWING PHRASES ARE APPLIED ONLY FOR U.S.A.:

CAUTION:

This equipment has been tested and found to comply with the limits for a Class B digital device, pursuant to Part 15 of the FCC Rules.

These limits are designed to provide reasonable protection against harmful interference in a residential installation. This equipment generates, uses and can radiate radio frequency energy and, if not installed and used in accordance with the instructions, may cause harmful interference to radio communications. However, there is no guarantee that interference will not occur in a particular installation. If this equipment does cause harmful interference to radio or television reception, which can be determined by turning the equipment off and on, the user is encouraged to try to correct the interference by one of the following measures:

- Reorient or relocate the receiving antenna.
- Increase the separation between the equipment and receiver.
- Connect the equipment into an outlet on a circuit different from that to which the receiver is connected.
- Consult the dealer or an experienced radio/TV technician for help.

FCC Notice: This system complies with new Part 15, except for the radio receiver, which complies with old Part 15, Subpart C of the FCC Rules. Operation is subject to the following two conditions: (1) This device may not cause harmful interference, and (2) this device must accept any interference received, including interference that may cause undesirable operation. The radio receiver is not subject to above item (2).

Any unauthorized changes or modifications to this equipment would void the user's authority to operate this device.

Power Sources

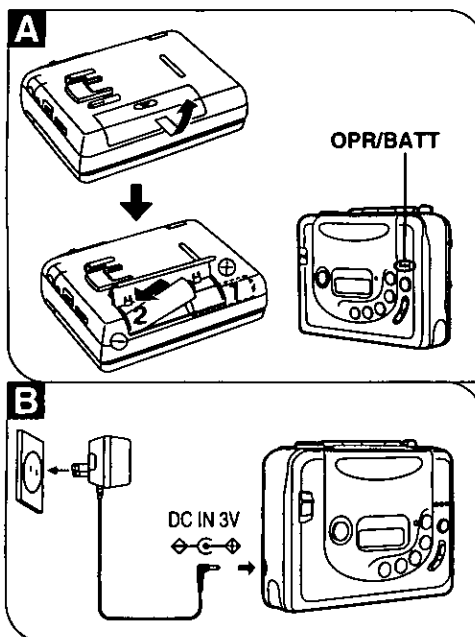

Dry cell batteries

Insert 2 AA size (R6/LR6 or equivalent, not included) batteries. Batteries installed with incorrect polarities may leak and damage this unit. Replace with fresh batteries of the same kind, observing polarity.

When the batteries are weak
The OPR/BATT indicator will turn off one by one.



This unit will turn off to protect the memorized contents. When replacing the batteries, manage it within 30 seconds, or the memorized contents will be cancelled.

AC power operation

Connect only Panasonic AC adaptor RP-AC31 (optional). If you disconnect the AC adaptor unit from the AC power outlet, the memorized contents for the radio will be cleared.

Tape Playback

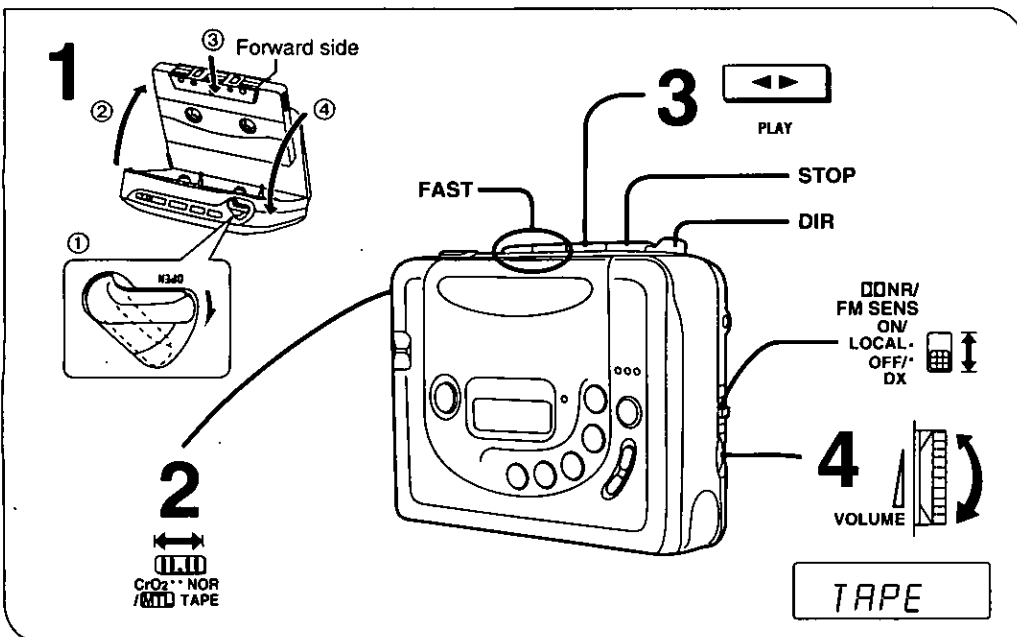

Normal, metal and high position (chrome) tapes can be used.

CrO₂ (MTC): Metal and high position (chrome) type
NOR: Normal type

Follow steps 1-4.

Play will be continued, looping forward and reverse side, until STOP is pressed.

To stop playback

Press STOP.

To fast forward and rewind

Press one of the FAST buttons.

The tape will rapidly move in the direction of the arrow.

◀◀: Fast forward for the forward side

▶▶: Rewind for the forward side

To change the tape direction

Press DIR to select the playback side.

To playback the tape with Dolby NR

Set NR selector to ON.

Dolby noise reduction manufactured under license from Dolby Laboratories Licensing Corporation. "DOLBY" and the double-D symbol are trademarks of Dolby Laboratories Licensing Corporation.

Notes:

- Do not open the cassette compartment cover during tape operation.
- Between functions (during play, fast forward or rewind), always press STOP first to avoid jamming the tape.
- When the tape reaches the end after fast forward or rewind, press STOP to release the FAST button.
- If you press RADIO ON/OFF to switch on the radio during tape operation, the button will not be released even though the motor has stopped. In this case, press STOP to release the button.

Listening to the Radio

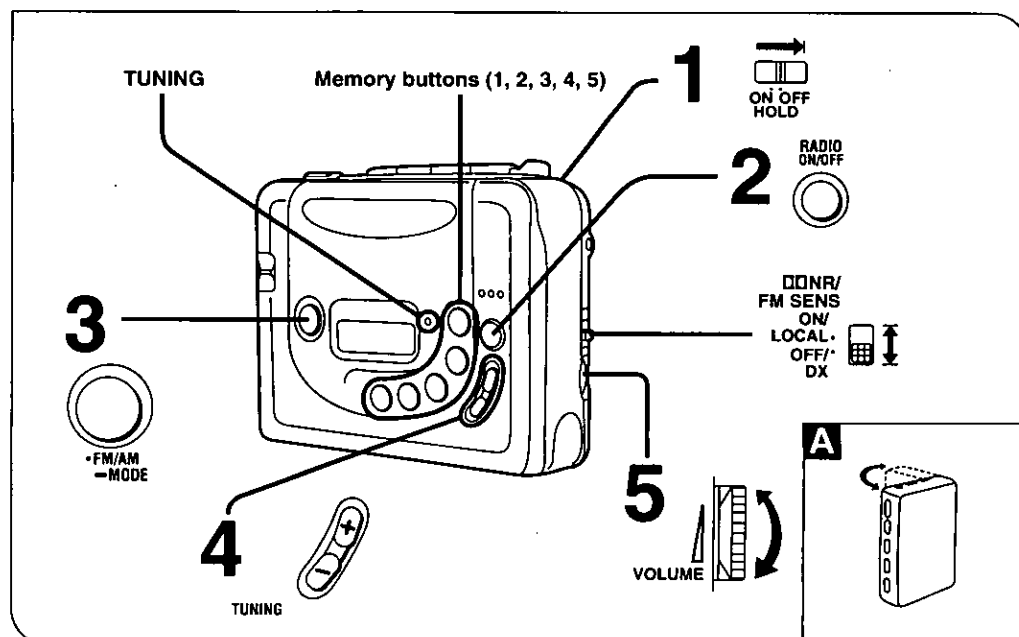

Follow steps 1-5.

When pressing FM/AM to select the band, release the button within 2 seconds.

To stop the radio

Press RADIO ON/OFF.

To obtain good reception

How to receive FM broadcasts clearly

Normally set the FM SENS selector to "DX". When the FM reception is impaired, or there is interference from a powerful station, set the selector to "LOCAL".

- This selector does not function for AM reception.

Antennas

FM:

Since the headphones cord serves as the FM antenna, be sure to use it extended, not coiled.

AM:

The built-in ferrite core AM antenna is directional. Turn the unit to obtain optimum reception.

- Be sure to have the set in a horizontal position.

When tuning into a station

The TUNING indicator will illuminate.

If it is an FM stereo broadcast, "STEREO" will be shown on the display.

Preset tuning

Total 20 stations can be stored.

You can store each station separately as follows.

MODE 1: FM: 1, 2, 3, 4, 5

AM: 1, 2, 3, 4, 5

MODE 2: FM: 1, 2, 3, 4, 5

AM: 1, 2, 3, 4, 5

We recommend that you use MODE 1 for daily, and MODE 2 for travel.

Mode selecting

Press and hold MODE for more than 2 seconds. **MODE1** or **MODE2** is shown on the display.

For your reference:

You can store the stations and change the allocation setting on each MODE1 and MODE2 individually.

Memory presetting

- Tune in the station to be stored.
- Press and hold one of the memory buttons (1, 2, 3, 4, 5) for about 2 seconds. 3 beeps can be heard.

Memory tuner operation

Press one of the memory buttons (1, 2, 3, 4, 5).

- Release the button within 2 seconds.



When using overseas

In order to accommodate the allocation in different countries, this unit has provided the tuning frequency in many increments.

Every time the following procedure is performed, the allocation setting changes in turn as follows.

FM 0.2 MHz, AM 10 kHz (original setting)

↓
FM 0.1 MHz, AM 10 kHz

↓
FM 0.05 MHz, AM 9 kHz

How to adjust the allocation settings

Before operation, switch on the radio and select the mode (MODE1 or MODE2).

- Press and hold both TUNING buttons (+ and -).
- While the TUNING buttons are pressed, press and hold MODE about 2 seconds. The changed allocation settings (FM and then AM) will appear on the display.

Note:

The memory for the each mode in which the steps were switched is cleared.

Changing the Tone

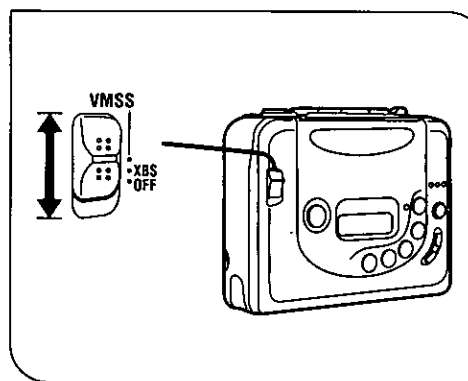

XBS

Boosts the low frequency range.

- If the sound distortion occurs, turn down the volume.

VMSS

Boosts the low frequency range. Also, the vibration of the earpieces of the included headphones makes sound vigorous.

Raising the volume level makes the VMSS effect intensify.

- VMSS does not function for AM reception.
- VMSS may not be effective according to the source.
- If you experience a ringing or discomfort in your ear while listening in VMSS mode, reduce volume or turn the VMSS mode OFF.